



Hergestellt in Frankreich
seit 1964

www.gys.fr



MAGNETISCHE SCHWEISSHILFEN

Für mehr Komfort beim Schweißen



Magnetische Schweißhilfen für mehr Komfort und Präzision beim Schweißen

MAGNETIC P 15.90

- Winkel: 60° und 90°
- max. 15 kg
- 100 x 73 x 12 mm
- x2



047044

MAGNETIC P 16.90

- Winkel: 45°, 90° und 135°
- max. 16 kg
- 45 x 32 x 28 mm
- x4

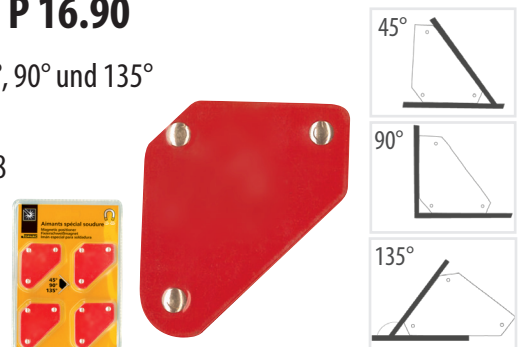

044180

MAGNETIC P 19.90

- Winkel: 45°, 90° und 135°
- max. 19 kg
- 156 x 102 x 20 mm
- x1

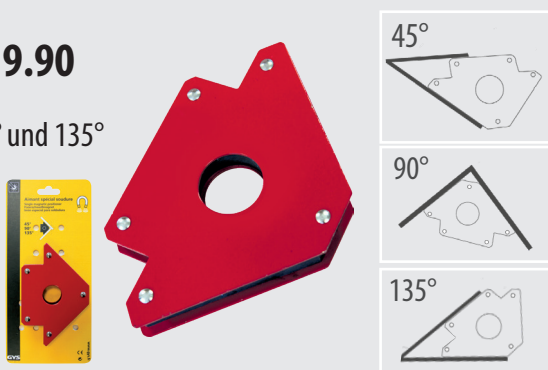

044203

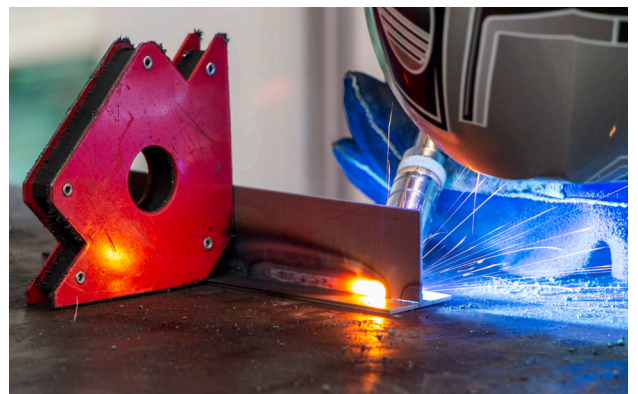

MAGNETIC P 20.180

- Winkel: 0° > 180°
- max. 20 kg
- 204 x 86 x 28 mm
- x1



044302

MAGNETIC D50.90 DUAL **Verschiebbar**

- Winkel: 90°
- max. 50 kg
- 148 x 148 x 38 mm
- x1



047051

MAGNETIC D36.90

Verschiebbar

- Winkel: 45°, 90° und 135°
- max. 30 kg
- 111 x 95 x 25 mm
- x1



044197

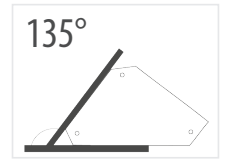
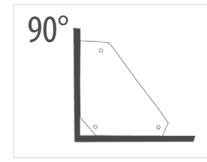
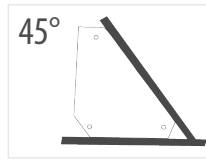

MAGNETIC D50.90

Verschiebbar

- Winkel: 90°
- max. 50 kg
- 71 x 60 x 48 mm
- x1



047075

MAGNETIC D70.90 M

Verschiebbar

- Winkel: 90°
- max. 70 kg
- 48 x 32 x 70 mm
- x1



047068

MAGNETIC D70.120M

Verschiebbar

- Winkel: 45°, 60°, 75°, 90°, 105° und 135°
- max. 70 kg
- 111 x 55 x 80 mm
- x1



047082

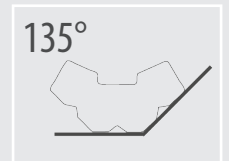
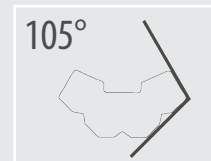
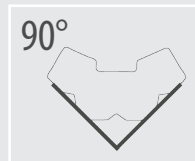
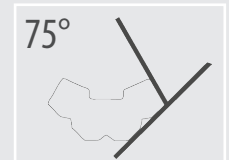
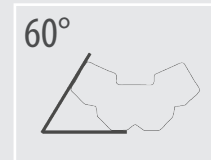
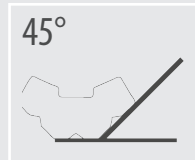

MAGNETIC D70.135M

Verschiebbar

- Winkel: 45°, 75°, 90°, 105° und 135°
- max. 70 kg
- 99 x 55 x 80 mm
- x1



047099

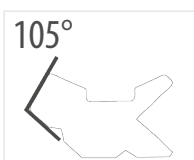
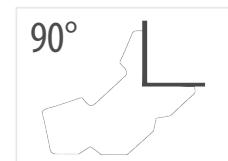
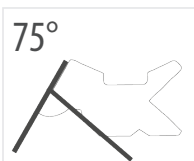
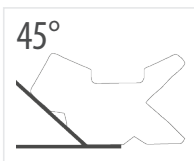



 **GYS Frankreich (HQ)**
1, rue de la Croix des Landes
CS 54159
53941 Saint-Berthevin - Cedex
Laval - Frankreich
Fax : (+33) 2 43 68 35 21
www.gys.fr / E-Mail : contact@gys.fr